

P3PC-1362-01EN

fi-553PR Imprinter *Operator's Guide*

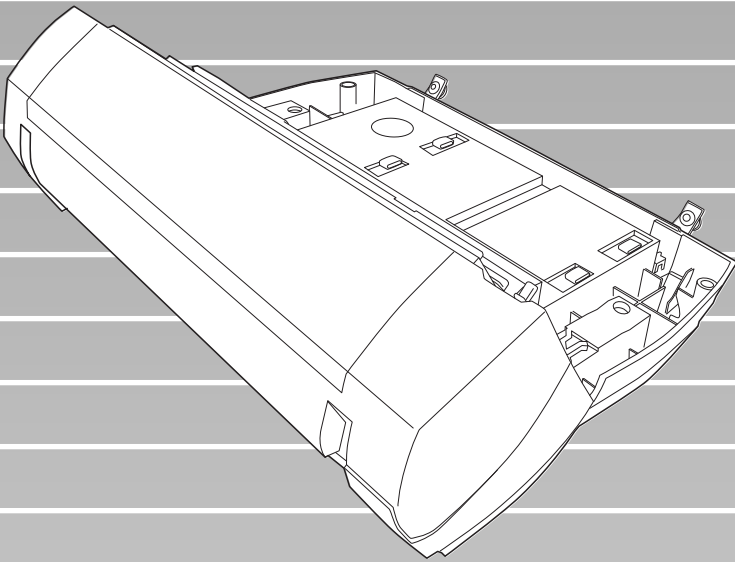

FUJITSU

Contents

Introduction	1
1. Preparations	4
1.1. Checking the Package Contents.....	4
1.2. Names and Functions of Parts.....	4
2. Installation	5
2.1. Installing the Imprinter.....	5
2.2. Mounting the Print Cartridge.....	6
2.3. Operation Test.....	7
3. Basic Operation	8
3.1. Setting Printing Position.....	8
3.2. Print Setup.....	8
3.3. Replacing the Print Cartridge.....	8
3.4. Removing Jammed Documents.....	10
4. Daily Care	11
4.1. Cleaning the Print Cartridge.....	11
4.2. Cleaning the Imprinter.....	11
4.3. Cleaning the Rollers.....	12
5. Error Messages	13
6. Specifications	14

All Rights Reserved, Copyright © PFU LIMITED 2005.

The contents of this manual are subject to change without notice.

This manual may not be reproduced, adapted or translated without prior written permission.

READ ALL OF THIS MANUAL CAREFULLY BEFORE USING THIS PRODUCT. IF THIS PRODUCT IS NOT USED CORRECTLY, UNEXPECTED INJURY MAY BE CAUSED TO USERS OR BYSTANDERS.

While all efforts have been made to ensure the accuracy of all information in this manual, PFU LIMITED assumes no liability to any party for any damage caused by errors or omissions or by statements of any kind in this manual, its updates or supplements, whether such errors are omissions or statements resulting from negligence, accidents, or any other cause.

PFU LIMITED further assumes no liability arising from the application or use of any product or system described herein; nor any liability for incidental or consequential damages arising from the use of this manual.

PFU LIMITED disclaims all warranties regarding the information contained herein, whether expressed, implied, or statutory.

PFU LIMITED assumes no liability for incidental or consequential damages arising from the use of this product, and any claims by a third party.

Introduction

Thank you for purchasing the fi-553PR Imprinter option for fi-5530C Color Image Scanner.

It helps you to organize your documents by printing a name, date, time or a serial number on the back side of the scanned document.

This guide explains how to install and use the Imprinter. This guide also contains important information such as procedures for Print Cartridge replacement. Keep this guide in convenient and safe place so that you can refer to it whenever necessary.

(For further details about the functions and operations of fi-5530C Image Scanner, refer to “fi-5530C Image Scanner Operator’s Guide” included in fi-5530C Setup CD-ROM.)

Manufacturer

PFU LIMITED

Image Products Sales Dept., Imaging Products
Division, Products Group
Solid Square East Tower, 580 Horikawa-cho,
Saiwai-ku, Kawasaki-shi Kanagawa 212-8563,
Japan
Phone : +81 (44) 540-4538

Trademarks

Microsoft, Windows, and Windows NT are registered trademarks of Microsoft Corporation in the United States and/or other countries. Other product names are the trademarks or registered trademarks of the respective companies.

How Trademarks Are Indicated In This Manual

References to operating systems (OS) are indicated as follows:

Windows 95:	Microsoft® Windows® 95 operating system.
Windows NT 4.0:	Microsoft® Windows NT® Server operating system version 4.0 Microsoft® Windows NT® Workstation operating system version 4.0.
Windows 98:	Microsoft® Windows® 98 operating system.
Windows Me:	Microsoft® Windows® Millennium Edition operating system.
Windows 2000:	Microsoft® Windows® 2000 Professional operating system.
Windows XP:	Microsoft® Windows® XP Professional operating system, Microsoft® Windows® XP Home Edition operating system.

Where there is no distinction between the different versions of the above operating system, the general term "Windows" is used.

Regulatory Information

FCC declaration

This equipment has been tested and found to comply with the limits for a Class B digital device, pursuant to Part 15 of the FCC Rules. These limits are designed to provide reasonable protection against harmful interference in a residential installation. This equipment generates, uses, and can radiate radio frequency energy and, if not installed and used in accordance with the instruction manual, may cause harmful interference to radio communications.

However, there is no guarantee that interference will not occur in a particular installation. If this equipment does cause harmful interference to radio or television reception, which can be determined by turning the equipment off and on, the user is encouraged to try to correct the interference by one or more of the following measures:

- Reorient or relocate the receiving antenna.
- Increase separation between equipment and receiver.
- Connect equipment to an outlet on a circuit different from that to which the receiver is located.
- Consult your dealer or an experienced radio/TV technician.

FCC Warning: Changes or modifications not expressly approved by the party responsible for compliance could void the user’s authority to operate the equipment.

Canadian DOC Regulations

This digital apparatus does not exceed the Class B limit for radio noise emissions from digital apparatus set out in the Radio interference Regulations of the Canadian Department of Communications.

This Class B digital apparatus complies with Canadian ICES-003.

Le présent appareil numérique n’émet pas de bruits radioélectriques dépassant les limites applicables aux appareils numériques de la classe B prescrites dans le Règlement sur le brouillage radioélectrique dicté par le ministère des Communications du Canada. Cet appareil numérique de la classe B est conforme à la norme NMB-003 du Canada.

Bescheinigung des Herstellers / Importeurs

Für den fi-553PR wird folgendes bescheinigt:

- In Übereinstimmung mit den Bestimmungen der EN45014(CE) funktentstört
- Maschinenlärminformationsverordnung 3. GPSGV, 06.01.2004: Der höchste Schalldruckpegel beträgt 70 dB (A) oder weniger, gemäß EN ISO 7779.

Use in High-safety Applications

This product has been designed and manufactured on the assumption that it will be used in office, personal, domestic, regular industrial, and general-purpose applications. It has not been designed and manufactured for use in applications (simply called "high-safety applications" from here on) that directly involve danger to life and health when a high degree of safety is required, for example, in the control of nuclear reactions at nuclear power facilities, automatic flight control of aircraft, air traffic control, operation control in mass-transport systems, medical equipment for sustaining life, and missile firing control in weapons systems, and when provisionally the safety in question is not ensured. The user should use this product with adopting measures for ensuring safety in such high-safety applications. PFU LIMITED assumes no liability whatsoever for damages arising from use of this product by the user in high-safety applications, and for any claims or compensation for damages by the user or a third party.

Conventions

Warning Indications Used In This Manual



This indication alerts operators to an operation that, if not strictly observed, may result in severe injury or death.



This indication alerts operators to an operation that, if not strictly observed, may result in safety hazards to personnel or damage to equipment.

Symbols Used In This Manual

This manual uses the following symbols in explanations in addition to warning indications



This symbol alerts operators to particularly important information. Be sure to read this information.



This symbol alerts operators to helpful advice regarding operation.



A TRIANGLE symbol indicates that special care and attention is required.

The drawing inside the triangle shows the specific caution.



A CIRCLE with a diagonal line inside shows action which users may not perform.

The drawing inside or under the circle shows the specific action that is not allowed.



Outline characters on a colored background show instructions users should follow.

It may also include the drawing that shows the specific instruction.

Screen Examples In This Manual

The screen examples in this manual are subject to change without notice in the interest of product improvement.

If the actual displayed screen differs from the screen examples in this manual, operate by following the actual displayed screen while referring to the User's Manual of the scanner application you are using. Furthermore, the screenshots in this manual are for Windows®, FUJITSU TWAIN 32 Scanner Driver.

About Maintenance



The user must not perform repairs on this scanner. Contact the store where you purchased the scanner or an authorized FUJITSU Image Scanner service provider to make repairs to this product.

Safety Precautions

FOLLOW THESE INSTRUCTIONS AND BE SURE TO HEED ALL WARNINGS AND CAUTIONS DESCRIBED BELOW.

⚠️ WARNING

- 

Do not touch the power plug with wet hands. Doing so might cause electric shock.
- 
- 

A damaged AC cable may cause fire or electric shock.
Do not place heavy objects on AC cables, or pull, bend, twist, heat, damage or modify AC cables.
Also, do not use damaged AC cables or power plugs, and AC cables or power plugs when the wall socket is loose.
- 

Do not use cables other than the ones supplied with this product. Use only specified AC cables and connector cables. Failure to use the correct cables might cause electric shock and equipment failure.
- 

Use this scanner only at the indicated power voltage and current. Improper power voltage and current might cause fire or electric shock.
Also, do not connect to multiple-power strips.
- 



Wipe off any dust from metal parts on the power plug or metal fittings with a soft, dry cloth. Accumulated dust might cause fire or electric shock.
- 

Do not install the scanner in locations subject to oil smoke, steam, humidity, and dust. Doing so might cause a fire or electric shock.
- 

If you detect heat coming from the device or detect other problems such as smoke, strange smells or noises, immediately turn off the scanner and then disconnect its power plug.
Make sure that the smoking has stopped, and then contact the store where you bought the scanner or an authorized FUJITSU scanner service provider.
- 

If the scanner is damaged for any reason, turn off the scanner and unplug the power cable before contacting the store where you purchased the scanner.
- 

Do not insert or drop metal objects into the scanner. Do not scan wet documents or documents with paper clips or staples.
Do not splash or allow the scanner to get wet.
- 

If foreign objects (water, small metal objects, liquids, etc.) get inside the scanner, immediately turn off the scanner and disconnect the power plug from the power outlet, then contact the store where you bought the scanner or the Maintenance Service Center. Pay particular attention to this warning in households where there are small children.
- 
- 

Do not take apart or modify the scanner. The inside of the scanner contains high-voltage components. Touching these components might cause fire or electric shock.

⚠️ CAUTION

The following describes important cautions.

- 

Install the scanner on a desk so that none of its parts protrude outside of the desktop. Also, make sure that the scanner is installed on a flat, level surface
- 

Do not install the scanner on unstable surfaces. Install the scanner on a level surface that is free of vibration to prevent it from falling.
Install the scanner on a strong surface that will support the weight of the scanner and other devices.
- 

Firmly insert the power plug into the power outlet as far it can go.
- 

Install the scanner away from strong magnetic fields and other sources of electronic noise. Also, protect the scanner from static electricity as this might cause the scanner to malfunction.
- 

Do not use aerosol sprays to clean the scanner. Aerosol sprays cause dirt and dust to enter the scanner, resulting in scanner failure and malfunction.
- 

When the scanner is not used for a long period, be sure to disconnect the power plug from the power outlet for safety.
- 

Do not install the scanner in the direct sunlight or near heating apparatus. Doing so might cause excessive heat to build up inside the scanner, causing fire or scanner trouble. Install the scanner in a well-ventilated location.
- 

Do not block the ventilation ports. Blocking the ventilation ports generates heat inside of scanner, which may result in fire or scanner failure.
- 

Do not place heavy objects on the scanner or use the scanner's top surface for performing other work. Improper installation might cause injuries.
- 

Do not move the scanner with the power and interface cables connected as this might damage the cables, causing fire, electric shock or injuries.
Before moving the scanner, be sure to disconnect the power plug from the power outlet, and disconnect data cables. Also, make sure that the floor is free of obstructions.
- 

Avoid touching any scanner mechanism when scanning as this may cause injuries.

1. Preparations

1.1. Checking the Package Contents

When you unpack the Imprinter package, make sure that all parts are included. Refer to the package contents list included in the Imprinter package box. If any components are missing, please contact the store where you purchased the Imprinter.

1.2. Names and Functions of Parts

<Imprinter Unit>

Front Side

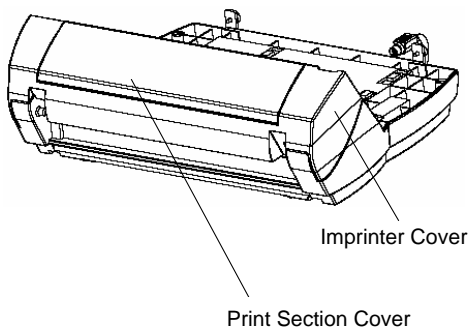

Rear Side

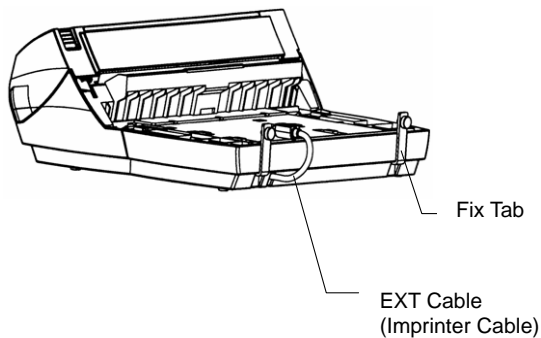

<Imprinter with Scanner Installed>

Front Side

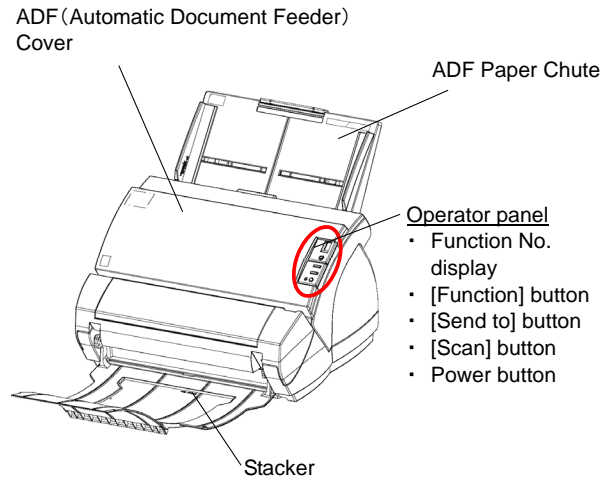

Rear Side

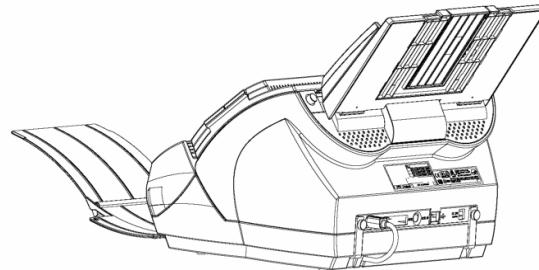

<Inside>

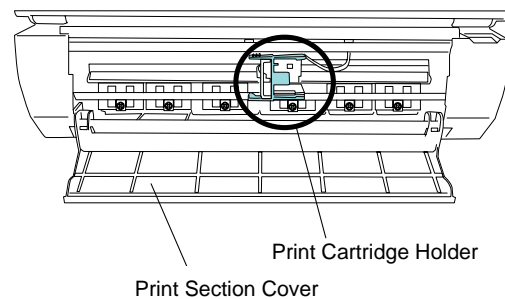

2. Installation

2.1. Installing the Imprinter

Install the Imprinter as follows:

1. Turn off the Scanner power and disconnect the power cable.
2. Remove the Stacker from the scanner.

Raise the Stacker upright as shown below while placing your fingers under the arms. Push the left arm gently towards the outside until you can release it towards you. Then do the same with the right arm to remove the Stacker completely.

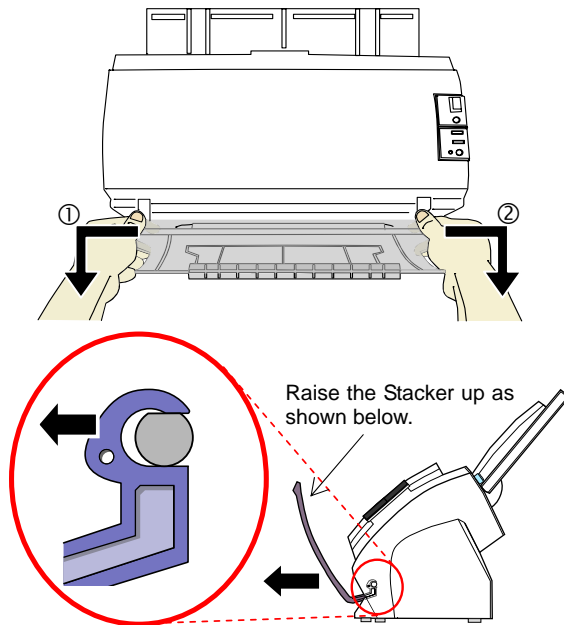

- You must remove the stacker before installing the Imprinter with the Scanner.
- Do not use force, since this might damage the Stacker.

3. Install the Scanner onto the Imprinter.

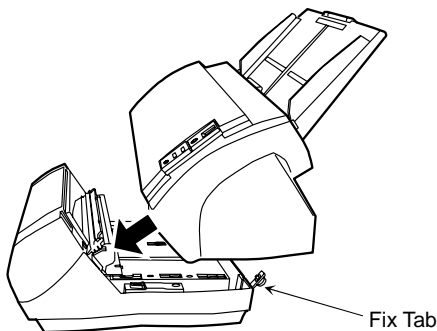

Hold the Scanner above the Imprinter rear. Gently place the Scanner onto the Imprinter base while lowering and pushing it forward until it touches the Imprinter.



- Be careful not to put the Scanner on the Fix Tabs or hitting it hard against them. You may damage the Fix Tabs.
- Be careful not to pinch your finger.

After installation

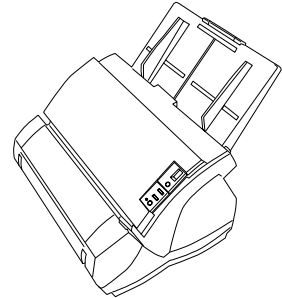
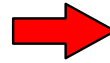

4. Insert the screws of the Fix Tabs to the rear of the scanner and tighten them to secure the Imprinter with the Scanner. (2 places)

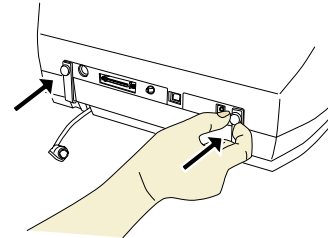

5. Connect the Imprinter cable (EXT Cable) to the connector on the rear of the Scanner.

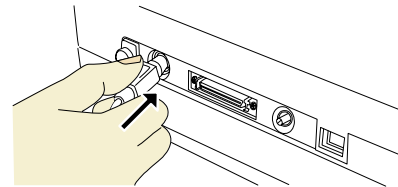

The Imprinter will not work if the EXT cable is not connected to the Scanner. Scanning when the EXT cable is not connected can cause documents to jam inside the Imprinter.

6. Install the Stacker removed in procedure 2 above to the Imprinter.

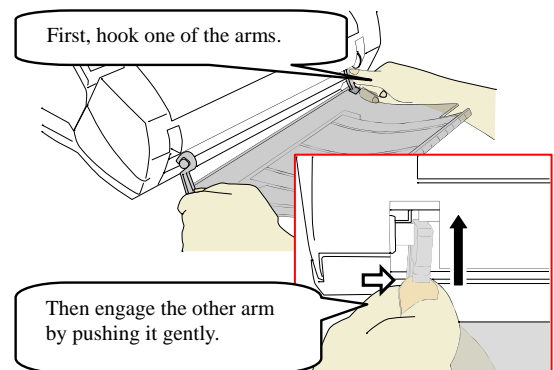

7. Connect the power cable to the scanner.

2.2. Mounting the Print Cartridge

Mount the print cartridge as follows:



When installing or replacing the Print Cartridge, be careful not to insert it out of place.

1. Confirm that the scanner is turned off.
2. Grab both ends of the Print Section Cover, pull and turn it towards you to open the cover.

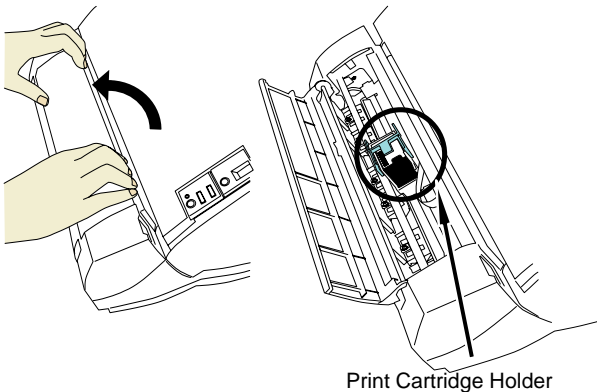

3. Remove the tape which fixes the Print Cartridge Holder.
4. Pinch the Arm with your fingers as shown below and release the Arm.

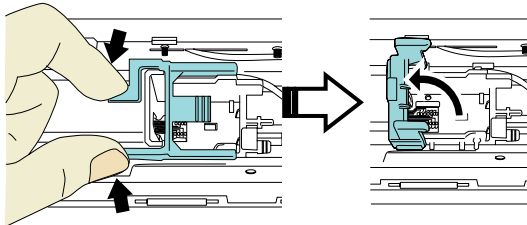

5. Take out the Print Cartridge from the bag.

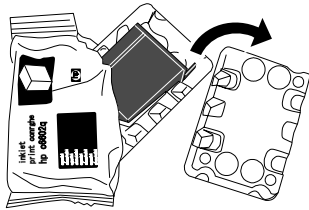

6. Remove protection tape on the Print Cartridge.

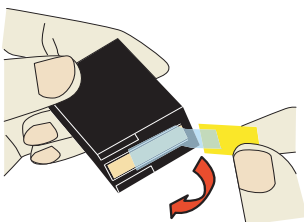

Do not touch the metal part of the Print Cartridge nor put the tape back again.

7. Put the Print Cartridge into the holder as below.

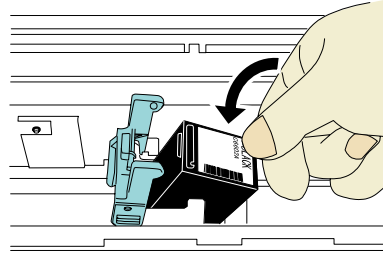

Be careful not to let the Print Cartridge catch the print circuit film.

8. Lower the Arm gently until it locks in and fix the Print Cartridge in place.

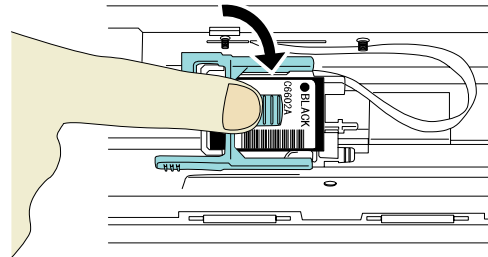

9. Move the Print Cartridge Holder to an appropriate printing position.

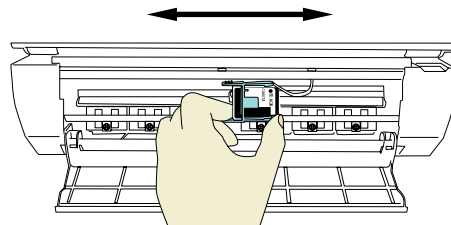

The holder should be positioned where the printing area of document (Section 6) will pass under it.

10. Close the Print Section Cover.

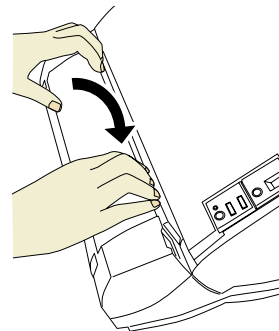

2.3. Operation Test

After installing the Imprinter, check if the printing operation can be done in the Offline Print Test mode of the scanner.

1. While pressing [Function] button on the operator panel, press  button.

Keep pressing [Function] button.

2. Release [Function] button when the Function Number Display changes from [P] to [b].

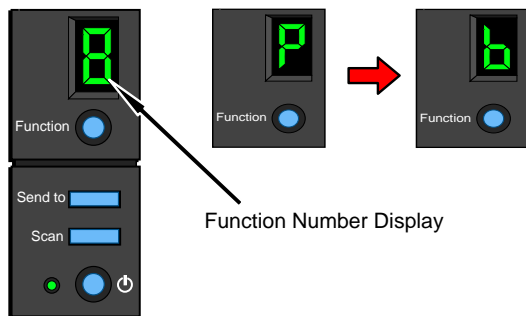

3. Place a blank document on the ADF paper chute.



- Use A4 or Letter size paper. If the size is smaller than A4 or Letter, printing may not be completed successfully.
- Confirm that the Print Cartridge is positioned within the document width.

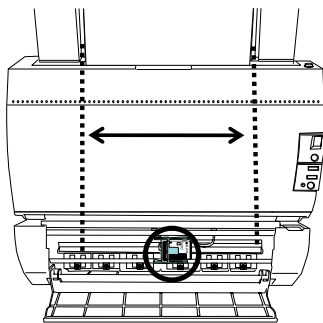

4. Press [Scan] button.

⇒ The paper is fed into the ADF. Test pattern 1 (① of the right figure) is printed on the paper starting 5mm (the range of error is ± 4 mm) from its leading edge.



There are following print test patterns:

Test pattern 1 (①) (Horizontal):

ABCDEFGHIJKLMNOPQRSTUVWXYZ[\]^_`0000
0000

Test pattern 2 (②) (Horizontal):

abcdefghijklmnopqrstuvwxyz{|}~ 00000000

Test pattern 3 (③) (Horizontal):

!"#\$%&()*+,-./0123456789:;<=>?@00000000

Test pattern 4 (④) (Vertical):

ABCDEFGHIJKLMNOPQRSTUVWXYZ[\]^_`00000000

Test pattern 5 (⑤) (Vertical):

abcdefghijklmnopqrstuvwxyz{|}~ 00000000

Test pattern 6 (⑥) (Vertical):

!"#\$%&()*+,-./0123456789:;<=>?@00000000

When multiple sheet of documents are set on the ADF, the Test print repeats the Pattern from 1 to 6. The numbering data portion "00000000" changes from 0 (Zero) with increment of 1 (one).

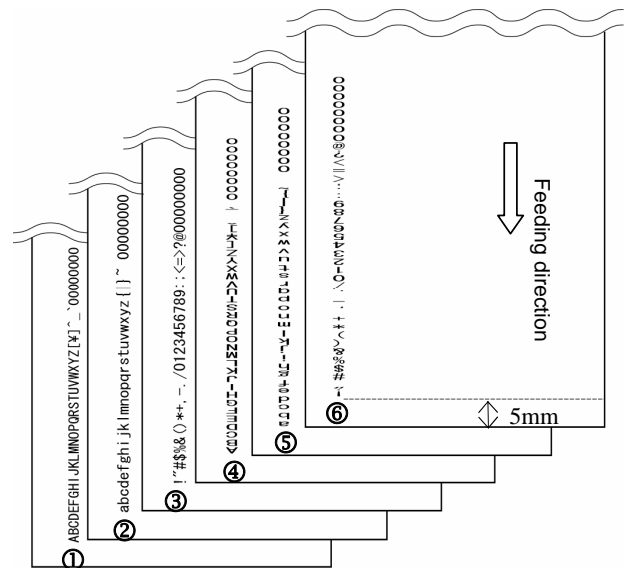

Test pattern print sample

5. To stop Offline Print Test mode, press  button. The scanner will be turned off.

3. Basic Operation

3.1. Setting Printing Position

1. Open the Print Section Cover.
2. Move the Print Cartridge Holder to an appropriate printing position.

Grab the Print Cartridge Holder as below, slide it to right or left (Section 6) and set it at a position where you want to print within the printing area of document.

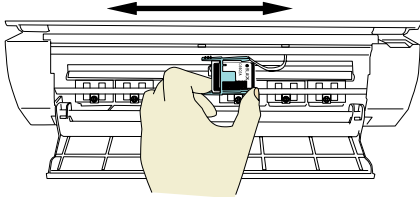

- The notch on the holder shows the print position.
- The Imprinter cover has document size markings. You can use them to align the notch to adjust the printing position.
- Put the actual document on the ADF to confirm that the Print Cartridge is positioned within the printing area of the document.

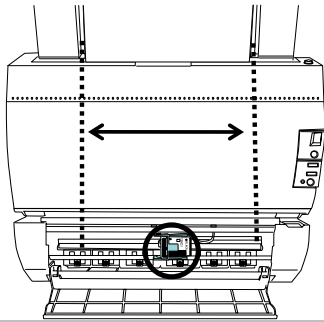

3.2. Print Setup

You can configure settings of the Imprinter with the scanner driver dialog box.

FUJITSU TWAIN driver (Example)

In the TWAIN driver dialog box, click [Option] button. In [Option] dialog box, choose [Imprinter (Endorser)] tab and specify the Imprinter settings.

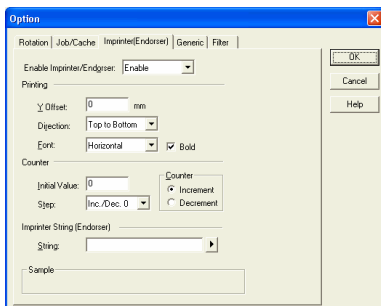

Available items are:

- Position to start printing (Y offset)
- Font orientation (Horizontal or vertical)
- String to print (Max. 40 characters)
- Counter Setup (column, add/subtract, step, etc.)

For the details, please refer to "FUJITSU TWAIN 32 Scanner Driver User's Guide" or "TWAIN Driver Help"

3.3. Replacing the Print Cartridge

Replace the Print Cartridge as follows:



- When the following message appears, replace the Print Cartridge as soon as possible.



If you keep on printing without replacing the Print Cartridge, light print problem may occur.

- When installing or replacing the Print Cartridge, be careful not to insert it out of place.

1. Press  button to turn off the Scanner.
2. Grab the both ends of the Print Section Cover, pull and turn it towards you to open the cover as shown below.

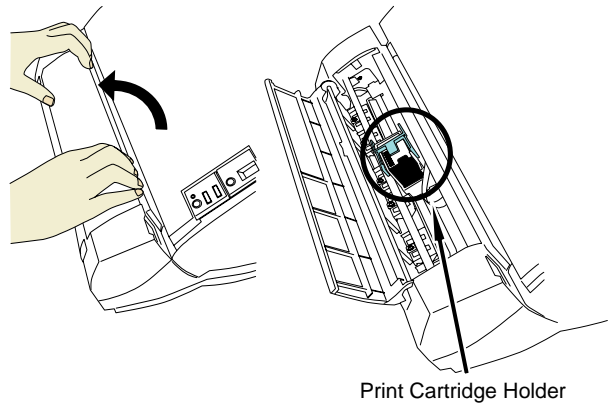

Print Cartridge Holder

- Pinch the Arm with your fingers as shown below and release the Arm.

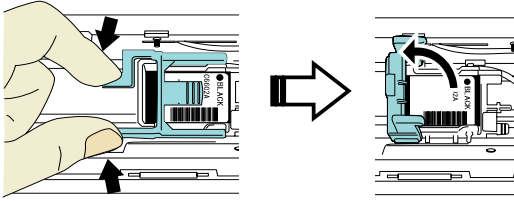

- Remove the old Print Cartridge.

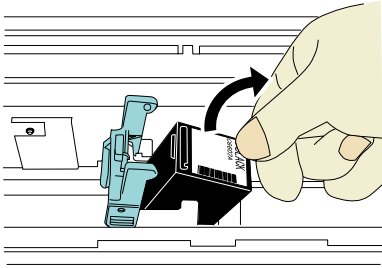

- Remove the protection tape on the new Print Cartridge.

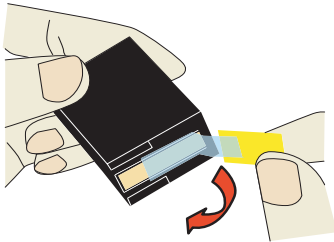

ATTENTION Do not touch the metal part of the Print Cartridge nor put the tape back again.

- Put the Print Cartridge into the holder with its tab pointing to the right.

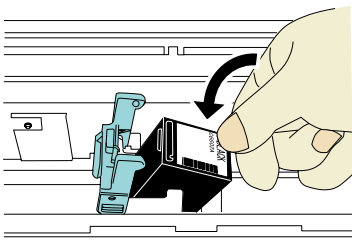

- Lower the Arm gently until it locks in to fix the Print Cartridge in place.

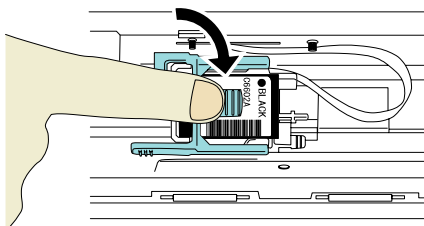

- Move the Print Cartridge Holder to an appropriate printing position.

The holder should be positioned where the printing area of document (Section 6) will pass under it.

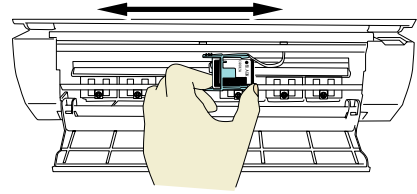

When printing close to document edge, be careful about the position so that characters may not be printed off of the document.

- Close the Print Section Cover.

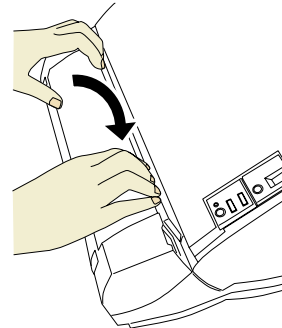

- Turn on the scanner.

- Reset the Remaining Ink Counter.



You must clear the Remaining Ink counter whenever you replace the Print Cartridge.

For Windows 98, Windows Me, Windows 2000, Windows XP

- On the [Start] menu, select [Control panel].
- Select [Scanners and Cameras].
- On fi-5530C icon, right click and select [Properties] (for Windows Me, Windows XP), or double click (for Windows 98, Windows 2000).
- Click the [Device Set] tab.
- Click the [Clear] button on [Remaining Ink].

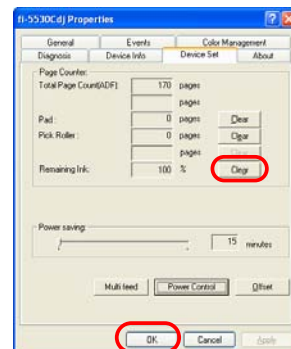

Click the [OK] button. A confirmation screen appears. Then click the [OK] button.

⇒ The Ink remain counter is reset to 100%.

For Windows 95, Windows NT 4.0

- ① Right-click the  icon in task bar and select [Option].
- ② Click the [Device Setting] tab.
- ③ Click the [Clear] button on [Remaining Ink].

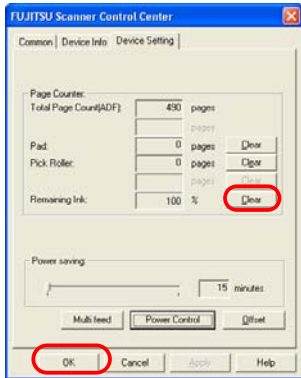

Click the [OK] button. A confirmation screen appears. Then click the [OK] button.

⇒ The Remaining Ink Counter is reset to 100%.

3.4. Removing Jammed Documents

If document jams, remove the jammed document as follows:



Open the covers to remove the jammed documents.
Do not pull out the documents forcefully.

1. Remove the documents in the ADF Paper chute.
2. Grab both ends of the Imprinter Cover, pull and turn it towards you to open the cover.

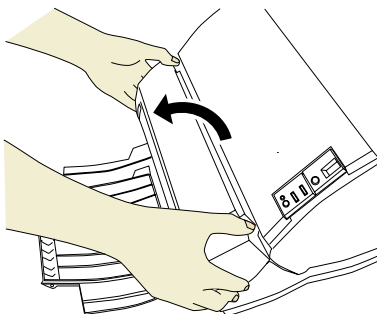

3. Open the ADF cover.

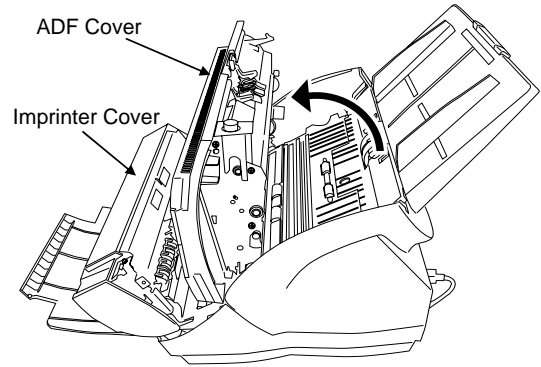

3. Remove the jammed documents.
4. Close the ADF cover.

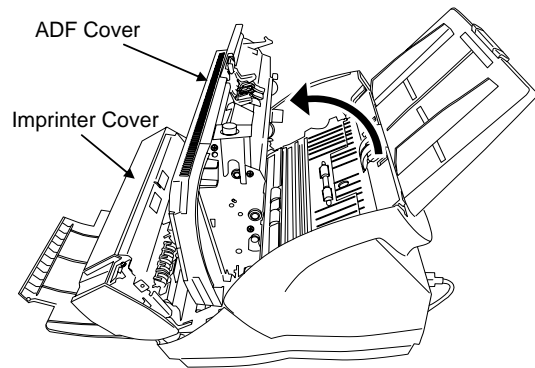

5. Grab both ends of the Imprinter Cover and close it.

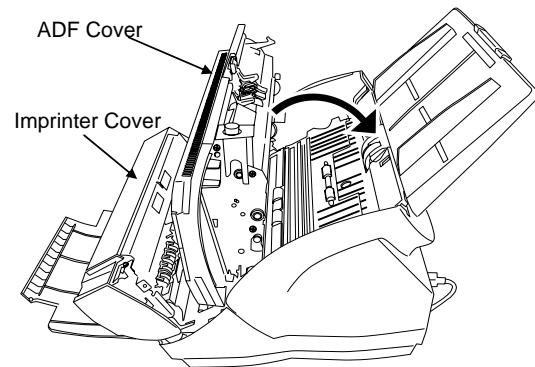

- Do not move the Imprinter and scanner while printing. Printing may be out of order.
- When you do not use the Imprinter for a long time, please remove the Print Cartridge from the Imprinter and store it.
- Ink will be consumed every time at the initial processing by the Imprinter even if no printing is performed.
- Do not move the scanner with the Imprinter installed. The Imprinter may get damaged.

4. Daily Care

4.1. Cleaning the Print Cartridge

Ink or stains stuck to the nozzle surface of the Print Cartridge or leaving the Imprinter unused for a while may cause poor print quality due to blocked ink emission holes in the nozzle. If your Imprinter has these types of trouble, clean the nozzle surface of the Print Cartridge.



For cleaning, use a dry lint-free cloth, and gently wipe off dirt and stain from the surface of the nozzle. (Do not use tissue.)

1. Press  button to turn off the Scanner.
2. Remove the Print Cartridge.
(Refer to “3.3. Replacing the Print Cartridge”.)

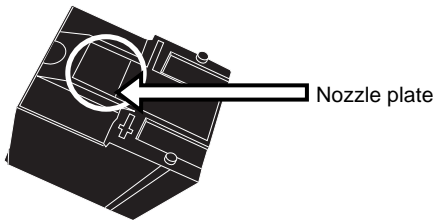

When cleaning, be careful not to touch the Nozzle plate or the contact parts of the cartridge directly by hand.

3. Gently wipe off the dirt and stain from the nozzle surface with a dry lint-free cloth.

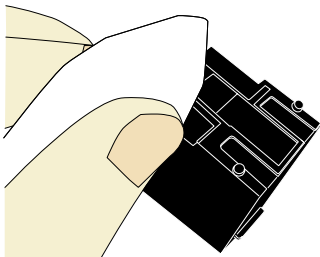

4. Make sure that the dirt and stain are all removed and then reinstall the Print Cartridge.

(Refer to “3.3. Replacing the Print Cartridge”.)



When installing or replacing the Print Cartridge, be careful not to insert it out of place.

4.2. Cleaning the Imprinter

While you use the Imprinter frequently, ink sticks to the Imprinter base and that makes the paper dirty. As a part of daily maintenance, clean the Imprinter base by following the procedure below.



- When cleaning, gently wipe off dust on the Imprinter base with an absorbent item that can remove the ink.
- If the ink is dried, gently wipe it with a moistened cloth. (Since the ink is water soluble, it can be cleaned with water.)

1. Press  button to turn off the Scanner.
2. Open the Print Cartridge Holder Cover and remove the Print Cartridge.
(Refer to “3.3. Replacing the Print Cartridge”.)
3. Open the Imprinter Cover.
4. Clean the Print Cartridge Holder base by pressing and wiping off the dirt with a lint-free cloth gently

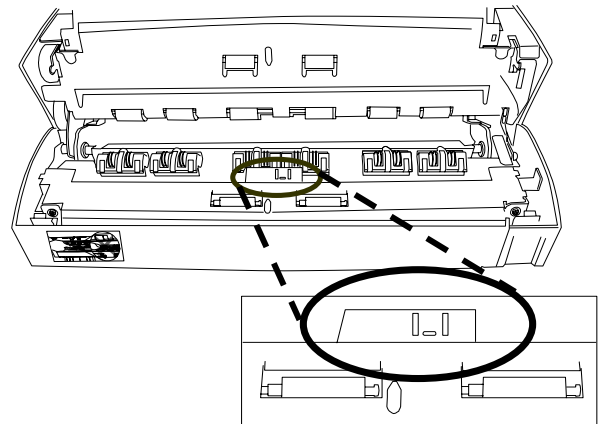

When cleaning, be careful not to touch the metal wheels located behind the upper rollers on the Print Cartridge Holder Cover.

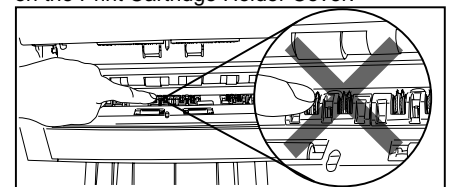

5. Check that the dirt is wiped off, then close the Imprinter Cover.
6. Reinstall the Print Cartridge.
(Refer to “3.3. Replacing the Print Cartridge”.)

4.3. Cleaning the Rollers

When ink or paper dust is stuck on the Imprinter feed roller surfaces, documents may not feed smoothly. To prevent feed problems, clean the roller surfaces regularly.



Recommended cleaning cycle is every 5,000 sheets. Actual cleaning cycle may be shorter depending on usage and documents.

1. Open the Imprinter Cover while the scanner is turned on.
2. With lint-free cloth, gently wipe off the dirt or dust to clean the roller surfaces.

Clean lower rubber rollers (total eight) rotating the rollers by holding down the [Scan] button and [Send to] button on the operator panel of the Scanner.

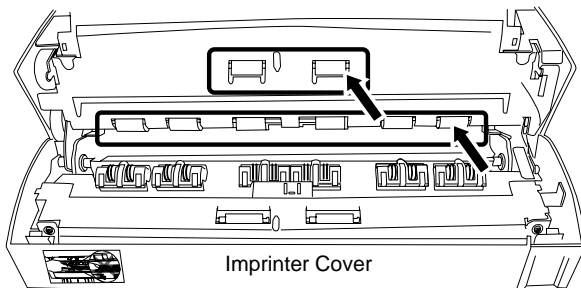

When cleaning, be careful not to touch the metal wheels located behind the upper rollers on the Print Cartridge holder cover.

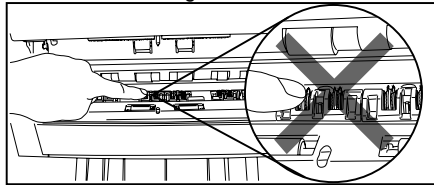

3. Clean the Plastic Rollers.

Clean two black plastic rollers on the inner side of the Imprinter Cover.

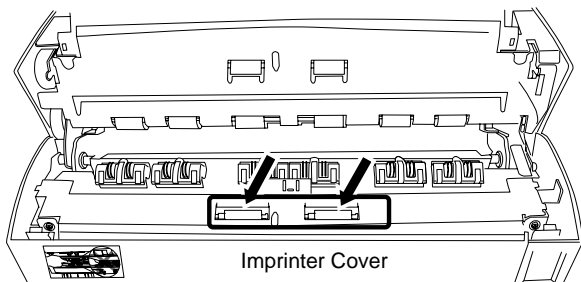

Rotate the rollers with your fingers gently wipe off the dirt or dust to clean the roller surface with lint-free cloth.

4. Confirm that the dirt or dust is removed from the rollers, then close the Imprinter Cover.

5. Error Messages

If the Function Number Display shows the following alternately, the Imprinter requires some intervention by customer..

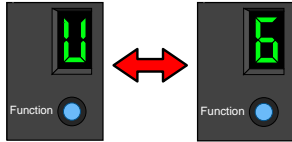

Description: The Print Cartridge is not installed.

How to solve: Open the Print Section Cover and confirm that the Print Cartridge is installed correctly.

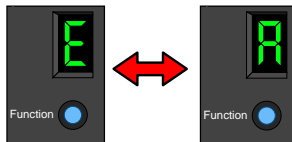

Description: A problem occurred to the Imprinter.

How to solve: ①Open the Print Section Cover and confirm that the Print Cartridge is installed correctly.
②Turn off the scanner and then turn it on again.
(If the problem occurs again, contact the store where you purchased the Imprinter or contact an authorized FUJISTU scanner service provider.)



For other errors, refer to "fi-5530C Image Scanner Operator's Guide" included in fi-5530C Setup CD-ROM.

6. Specifications

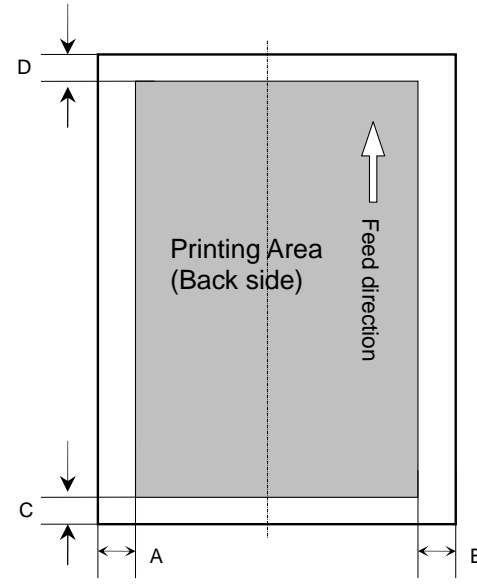
Item	Specification
Printing Method	Thermal inkjet printing
Print Timing	Post printing
Printing Characters	Alphabet : A to Z, a to z Numeric Characters : 0, 1 to 9 Symbols : ! " \$ # % & ' () * + , - . / : ; < = > ? @ [\] ^ _ ` { } ~
Maximum number of characters per line	40 characters (When using 8 digits counter: 43 characters)
Font orientation	Normal: 0°, 180° (horizontal), 90°, 270° (vertical) Narrow: 0°, 180° (horizontal)
Character size	Normal : Height 2.91 × width 2.82mm / 0.1146 × 0.1110 in (horizontal), Height 2.82 × width 2.91mm / 0.1110 × 0.1146 in (vertical) Narrow: Height 2.91 × width 2.12mm / 0.1146 × 0.0835 in (horizontal)
Character pitch	3.53mm (Normal), 2.54mm (Narrow)
Font Style	Regular, Bold
Character width	Normal, Narrow
Document that can be scanned	Documents supported by fi-5530C For the details, please refer to “fi-5530C Image Scanner Operator’s Guide”-“Chapter 6 Document Specification for the ADF.” <hr/>  <ul style="list-style-type: none"> Documents with glossy surface such as thermal paper, thermal transfer paper, coated paper and art paper, take longer time for the ink to dry and may cause poor print quality. The Imprinter must be cleaned more frequently if you use these types of papers. Very thick paper or plastic document cannot be scanned when the imprinter is installed. <hr/>
Printing area	<p>A = 5mm B = 5mm C = 5mm D = 5mm</p> 
Accuracy of Printing position	±4mm from the starting point for feeding direction
Dimension	Without Scanner : 399(W) × 302(D) × 151(H) mm With Scanner : 399(W) × 546(D) × 352(H) mm
Weight	Without Scanner : 3.5kg
Ambient condition	Temperature: 10 to 35°C, Humidity: 20 to 80%
Consumable	Print Cartridge (P/N: CA00050-0262) Replacement Cycle : 4,000,000 characters (The number of characters may decrease depending on the font selection.)